

Rev	Redrower	Date	Modification
A	Sugiyama	2019.6.25	初版

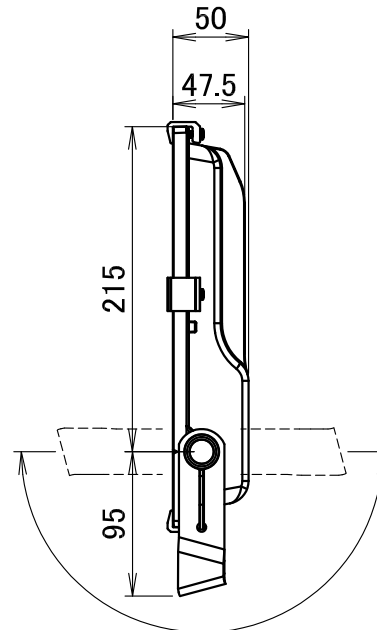

180度  
アーム可動角度

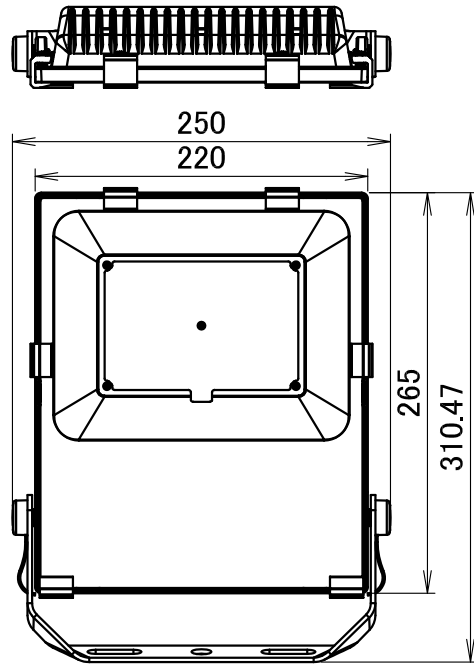
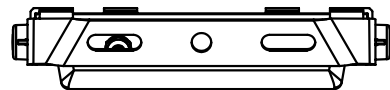
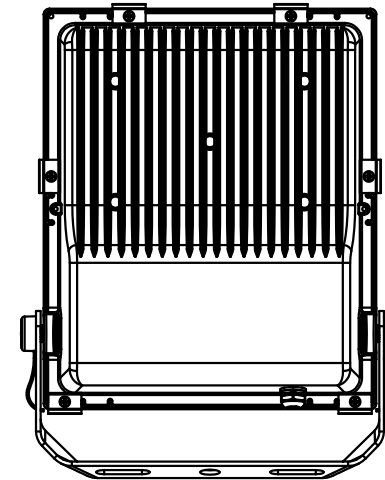

取付金具寸法

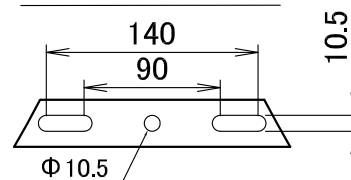

単位: mm

Presented by		株式会社ダイク			
Drowed by	Sugiyama	2019.6.25	Scale	1 / 5	trigonometry
Approved by	Mitaki	2019.6.25	Design Name FH-254s-40W 外形図		
Customer	技術資料		Design Num		Revision
Date	2019.6.25		DA4-00302		A